

FLOOR CONVECTORS

PKH

Application

- Perfect for use in areas with high interior design requirements and spaces with large glass surfaces.
- Attractive solution used both as a primary or secondary heat source in water heating and/or cooling systems.

Features

- Steel sheet casing powder coated in black color - RAL9005. Optional external 6 mm tick insulation.
- Cu/Al heat exchanger with profiled fins and 1/2" internal thread connections; each tested on 25 bar max pressure.
- Low noise tangential fans: 230V AC or 24V EC
- Wide range of attractive cover grilles made of anodized aluminium, wood or stainless steel in longitudinal or transverse roll-up design.
- Modular design allows easy connection and section adjustments
- Variety of accessories, regulation and inactive connection parts.

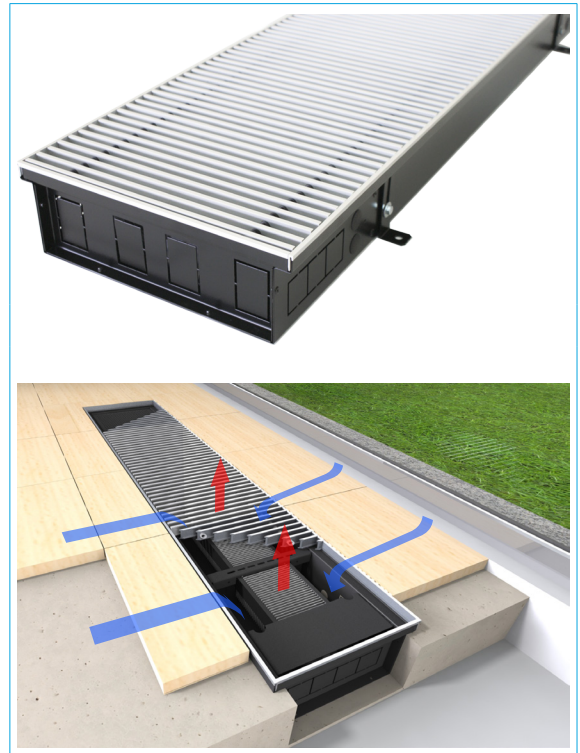

Advantages

Intersecting cold air stream

In rooms with large glass surfaces, cold air downwash is present from glass surfaces towards the rest of the room. Floor convectors intersect the cold air stream, creating a warm barrier between cold glass surface and the rest of the room. It improves the room comfort and prevents fogging of the glass surfaces.

Cost effective

As an addition to floor heating system, floor convectors are great solution for short-term heating requirements during transitional periods between seasons. In this way heating is only delivered when necessary, avoiding unwanted heat transfer and saving money.

Instant heating

Heat exchangers provide rapid heat transfer due to large heat exchange surface. It is especially beneficial in combination with slow heating systems.

High heat output at low input water temperatures

In heating systems with low water temperatures, floor convectors with forced convection are used. The principle of forced convection greatly increases heat output.

Attractive design

Compared to classical heating systems, floor convectors are not using up usefull space nor interfering with room arrangement.

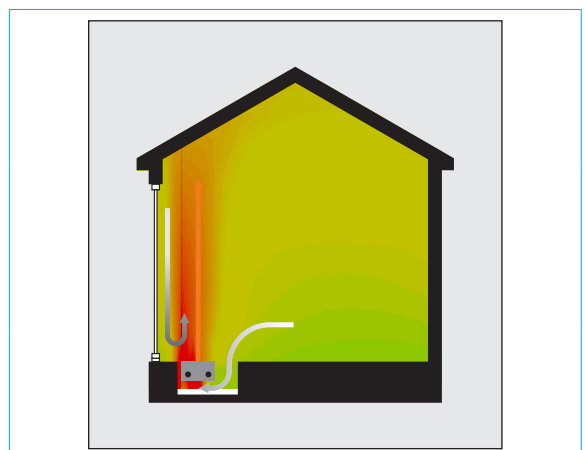
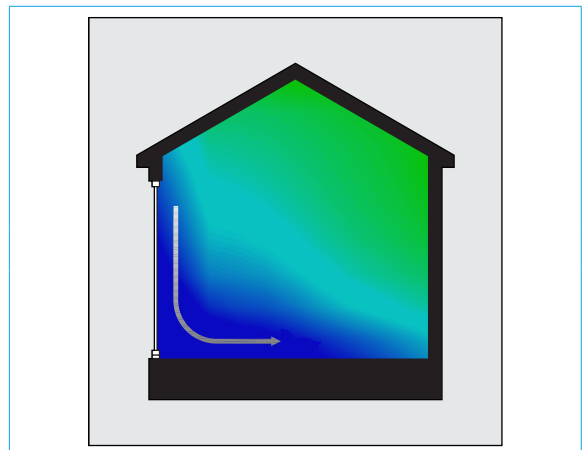

PKH | HEATING or COOLING

- 2-pipe system for heating or cooling
- Condensate drain included

Length: 1200 to 3000 mm
 Height: 130 or 150 mm
 Heat output: 1105 - 13006 W
 Cooling output: 406 - 4757 W

Fans / Controls
 230 V AC - 3 speed transformer
 230 V AC - control 0-10 V
 24 V EC - control 0-10 V
 12 V DC - on request

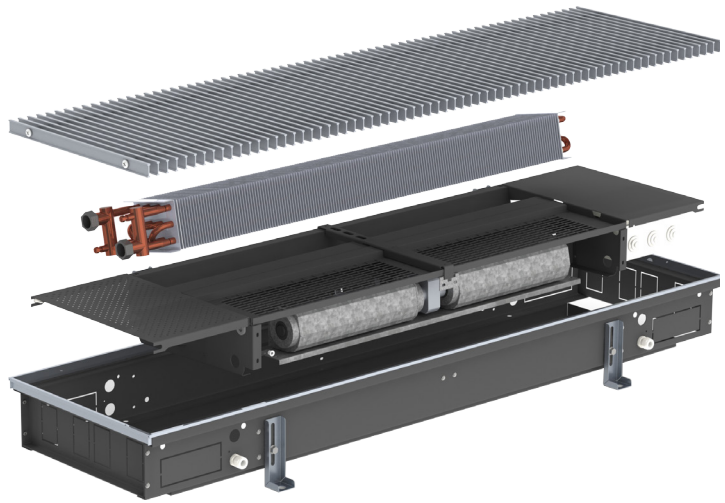

| | | PKH-130 | | | | | | PKH-150 | | | | | |
|-----------------------------|-----|-------------|-------------|-------------|------------|-------------|-------------|-------------|-------------|-------------|------------|-------------|-------------|
| | | LPHW | | | LPCW | | | LPHW | | | LPCW | | |
| | | 90/70/20 °C | 75/65/20 °C | 55/45/20 °C | 6/12/26 °C | 10/15/26 °C | 12/16/26 °C | 90/70/20 °C | 75/65/20 °C | 55/45/20 °C | 6/12/26 °C | 10/15/26 °C | 12/16/26 °C |
| L = 1200 mm (1 fan) | | | | | | | | | | | | | |
| Fan speed | MIN | 2610 | 1790 | 1105 | 726 | 517 | 454 | 2677 | 2231 | 1335 | 717 | 443 | 406 |
| | MED | 3016 | 2537 | 1568 | 841 | 615 | 525 | 3448 | 2832 | 1684 | 1026 | 790 | 689 |
| | MAX | 3683 | 3069 | 1892 | 1019 | 754 | 655 | 4600 | 3647 | 2209 | 1384 | 1013 | 893 |
| L = 2000 mm (2 fans) | | | | | | | | | | | | | |
| Fan speed | MIN | 5015 | 4083 | 2250 | 1309 | 909 | 876 | 5331 | 4494 | 2663 | 1364 | 861 | 843 |
| | MED | 5867 | 4802 | 3041 | 1682 | 1094 | 1086 | 6806 | 5644 | 3422 | 2340 | 1751 | 1356 |
| | MAX | 7366 | 5953 | 3763 | 2461 | 1596 | 1588 | 8703 | 7412 | 4402 | 2978 | 2001 | 1607 |
| L = 2600 mm (3 fans) | | | | | | | | | | | | | |
| Fan speed | MIN | 7369 | 6124 | 3375 | 2252 | 1523 | 1343 | 7832 | 6574 | 3983 | 2563 | 1749 | 1547 |
| | MED | 8801 | 7203 | 4561 | 2744 | 1872 | 1623 | 9920 | 8501 | 4925 | 3241 | 2264 | 1977 |
| | MAX | 11050 | 8930 | 5645 | 3462 | 2224 | 2162 | 12847 | 10529 | 6309 | 4294 | 3039 | 2697 |
| L = 3000 mm (3 fans) | | | | | | | | | | | | | |
| Fan speed | MIN | 7523 | 6201 | 3620 | 2302 | 1771 | 1538 | 7910 | 6669 | 3952 | 2808 | 1942 | 1676 |
| | MED | 8903 | 7346 | 4725 | 2873 | 2124 | 1918 | 10047 | 8332 | 5052 | 3527 | 2453 | 2142 |
| | MAX | 11357 | 9145 | 5921 | 3926 | 2848 | 2469 | 13006 | 10751 | 6372 | 4757 | 3306 | 2887 |

Dimensions - PKH

PKH-130

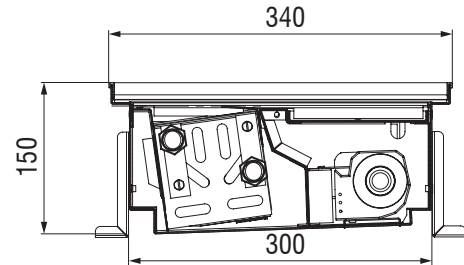
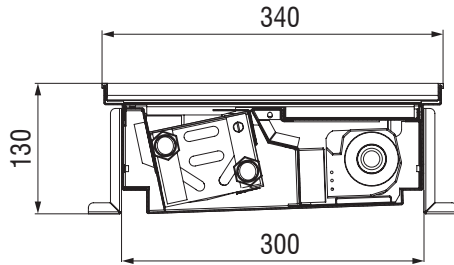

PKH-150

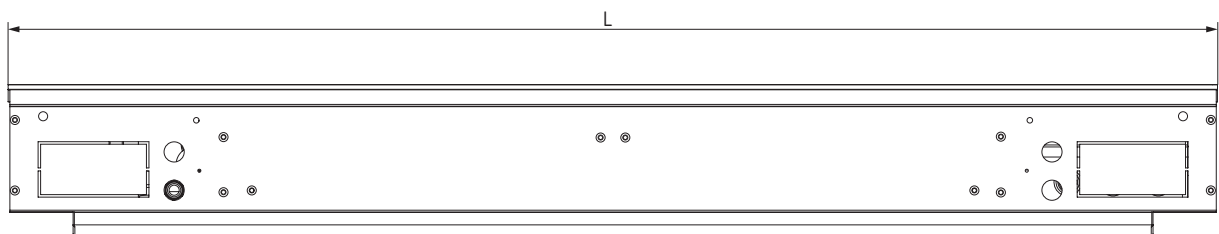
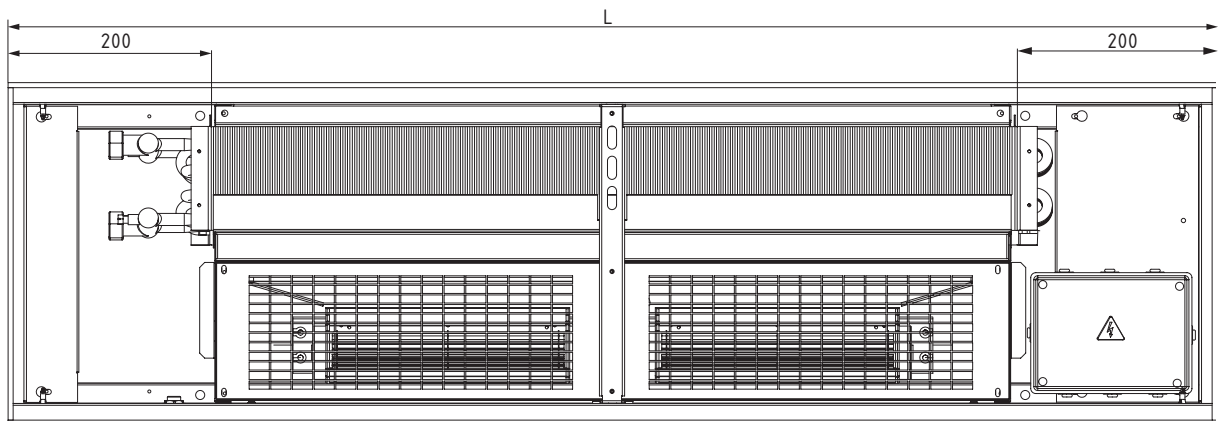

*water connections R1/2"

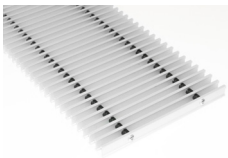
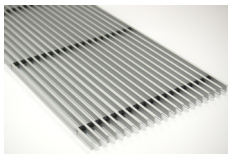

ACCESSORIES

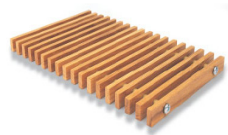
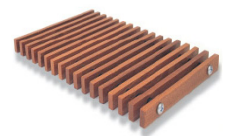
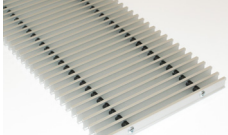
| Image | Description | Code | Suitable for |
|---|---|----------|---------------------------|
|  | Roll-up aluminium grille (anodized in natural color) | QL-501-1 | All models - 1 row |
| | | QL-501-2 | All models - 2 row |
| | | QL-501-3 | All models - 3 row |
| | Roll-up al. grille - anodized (light bronze, bronze, light brown, brown, black) | QL-502-1 | All models - 1 row |
| | | QL-502-2 | All models - 2 row |
| | | QL-502-3 | All models - 3 row |
| | Roll-up al. grille - RAL... | QL-503-1 | All models - 1 row |
| | | QL-503-2 | All models - 2 row |
| | | QL-503-3 | All models - 3 row |
|  | Linear aluminium grille (anodized in natural color) | QL-504-1 | All models - 1 row |
| | | QL-504-2 | All models - 2 row |
| | | QL-504-3 | All models - 3 row |
| | Linear al. grille - anodized (light bronze, bronze, light brown, brown, black) | QL-505-1 | All models - 1 row |
| | | QL-505-2 | All models - 2 row |
| | | QL-505-3 | All models - 3 row |
| | Linear al. grille - RAL... | QL-506-1 | All models - 1 row |
| | | QL-506-2 | All models - 2 row |
| | | QL-506-3 | All models - 3 row |
|  | Roll-up grille - beech | QL-507-1 | All models - 1 row |
| | | QL-507-2 | All models - 2 row |
| | | QL-507-3 | All models - 3 row |
|  | Roll-up grille - oak | QL-508-1 | All models - 1 row |
| | | QL-508-2 | All models - 2 row |
| | | QL-508-3 | All models - 3 row |
|  | Roll-up grille - cherry | QL-509-1 | All models - 1 row |
| | | QL-509-2 | All models - 2 row |
| | | QL-509-3 | All models - 3 row |
|  | Roll-up grille - inox | QL-510-1 | All models - 1 row |
| | | QL-510-2 | All models - 2 row |
| | | QL-510-3 | All models - 3 row |



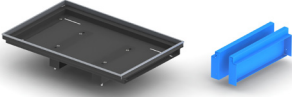
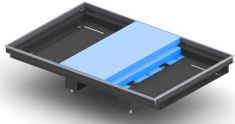
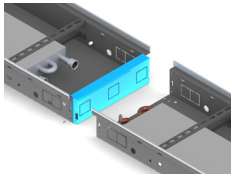



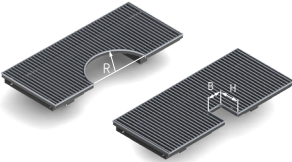



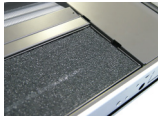



ACCESSORIES

| Image | Description | Code | Suitable for | |
|---|-------------------------------------|------------------------------------|------------------------------|-------------------|
|  | Optional F frame | QL-511 | All models | |
|  | Inactive section set (L=250 mm) | QL-512-701 | PKN 70 | 1-row |
| | | QL-512-702 | | 2-row |
| | | QL-512-703 | | 3-row |
| | | QL-512-111 | PKN 110 / PKF 110 | 1- row |
| | | QL-512-112 | | 2-row |
| | | QL-512-113 | | 3-row |
| | | QL-512-132 | PKH 130 | |
| | | QL-512-141 | PKN 140 / PKF 140 | 1-row |
| | | QL-512-142 | | 2-row |
| | | QL-512-143 | | 3-row |
| | | QL-512-152 | PKH 150 | |
| | | Inactive section set (L=500 mm) | QL-513-701 | PKN 70 |
| | QL-513-702 | | 2-row | |
| | QL-513-703 | | 3-row | |
| | QL-513-111 | | PKN 110 / PKF 110 | 1- row |
| | QL-513-112 | | | 2-row |
| | QL-513-113 | | | 3-row |
| | QL-513-132 | | PKH 130 | |
| | QL-513-141 | | PKN 140 / PKF 140 | 1-row |
| | QL-513-142 | | | 2-row |
| | QL-513-143 | | | 3-row |
| | QL-513-152 | | PKH 150 | |
| | Inactive section set (L=1000 mm) | | QL-514-701 | PKN 70 |
| | | QL-514-702 | 2-row | |
| | | QL-514-703 | 3-row | |
| | | QL-514-111 | PKN 110 / PKF 110 | 1- row |
| | | QL-514-112 | | 2-row |
| QL-514-113 | | 3-row | | |
| QL-514-133 | | PKH 130 | | |
| QL-514-141 | | PKN 140 / PKF 140 | 1-row | |
| QL-514-142 | | | 2-row | |
| QL-514-143 | | | 3-row | |
| QL-514-153 | | PKH 150 | | |
|  | | Load bearing cover | QL-515-701 | All models |
| | QL-515-702 | | 2-row | |
| | QL-515-703 | | 3-row | |
|  | Casing connection piece | QL-516-701 | PKN 70 | 1-row |
| | | QL-516-702 | | 2-row |
| | | QL-516-703 | | 3-row |
| | | QL-516-111 | PKN 110 / PKF 110 | 1- row |
| | | QL-516-112 | | 2-row |
| | | QL-516-113 | | 3-row |
| | | QL-516-132 | PKH 130 | |
| | | QL-516-141 | PKN 140 / PKF 140 | 1-row |
| | | QL-516-142 | | 2-row |
| | | QL-516-143 | | 3-row |
| | | QL-516-152 | PKH 150 | |

ACCESSORIES

| Image | Description | Code | Suitable for | |
|---|--------------------------------------|---|------------------------------|--------|
|  | Cut out section | QL-517-701 | PKN 70 | 1-row |
| | | QL-517-702 | | 2-row |
| | | QL-517-703 | | 3-row |
| | | QL-517-111 | PKN 110 / PKF 110 | 1- row |
| | | QL-517-112 | | 2-row |
| | | QL-517-113 | | 3-row |
| | | QL-517-132 | PKH 130 | |
| | | QL-517-141 | PKN 140 / PKF 140 | 1-row |
| | | QL-517-142 | | 2-row |
| | | QL-517-143 | | 3-row |
| | | QL-517-152 | PKH 150 | |
| | |  | Curved section | QL-518 |
|  | Corner section 90° Roll-up grille | QL-519-701 | PKN 70 | 1-row |
| | | QL-519-702 | | 2-row |
| | | QL-519-703 | | 3-row |
| | | QL-519-111 | PKN 110 / PKF 110 | 1- row |
| | | QL-519-112 | | 2-row |
| | | QL-519-113 | | 3-row |
| | | QL-519-132 | PKH 130 | |
| | | QL-519-141 | PKN 140 / PKF 140 | 1-row |
| | | QL-519-142 | | 2-row |
| | | QL-519-143 | | 3-row |
| | QL-519-152 | PKH 150 | | |
| | Corner section 90° Linear grille | QL-520-701 | PKN 70 | 1-row |
| | | QL-520-702 | | 2-row |
| | | QL-520-703 | | 3-row |
| | | QL-520-111 | PKN 110 / PKF 110 | 1- row |
| | | QL-520-112 | | 2-row |
| | | QL-520-113 | | 3-row |
| | | QL-520-132 | PKH 130 | |
| | | QL-520-141 | PKN 140 / PKF 140 | 1-row |
| | | QL-520-142 | | 2-row |
| QL-520-143 | | 3-row | | |
| QL-520-152 | PKH 150 | | | |

ACCESSORIES

| Image | Description | Code | Suitable for |
|---|---|---------------|---|
|  | Filter G2 | QL-521 | PKF, PKH, PKH-4C (230V AC and 24V EC) |
| | External casing insulation | QL-522 | All models |
|  | Control box AT6 | QL-523 | PKF, PKH, PKH-4C (230V AC) |
|  | Control box AT6-Relay | QL-524 | PKF, PKH, PKH-4C (230V AC) |
|  | Silent drive (230V AC; 0-10V) | QL-525 | PKF, PKH, PKH-4C (230V AC) |
|  | Room thermostat - wall (Siemens RAA 21) | QL-526 | PKN |
|  | Analog 3-step thermostat - wall (Siemens RAB 11) | QL-527 | PKF, PKH (230V AC) |
|  | Analog 3-step thermostat - wall (Siemens RAB 31) | QL-528 | PKH-4C (230V AC) |
|  | Digital thermostat - flush (Siemens RDF 510) | QL-529 | PKF, PKH (230V AC) |
|  | Digital thermostat - flush (Siemens 400.01) | QL-530 | PKF, PKH, PKH-4C (230V AC) |
|  | Frame for RDF thermostat | QL-531 | |
|  | Remote control for RDG and RDF | QL-532 | |
|  | Digital thermostat - wall (Siemens RDG 100T) | QL-533 | PKF, PKH, PKH-4C (230V AC) |
|  | Digital thermostat 0-10V - wall (Seitron TFZ01M) | QL-534 | PKF, PKH, PKH-4C (230V AC) |
|  | KOER Codis C35-FC (Temp.) | C35-FC | PKF, PKH, PKH-4C (230V AC and 24V EC) |
| | KOER Codis C35-FC-B/RS (Temp.-BACnet) | C35-FC-B/RS | |
| | KOER Codis C35-FC-H (Temp.-Humidity) | C35-FC-H | |
| | KOER Codis C35-FC-H-B/RS (Temp.-Humidity-BACnet) | C35-FC-H-B/RS | |

ACCESSORIES

| Image | Description | Code | Suitable for |
|---|--|------------------|-------------------|
|  | Service valve 1/2" Service valve 3/4" | QL-535 QL-536 | All models |
|  | Radiator valve straight 1/2" Radiator valve angled 1/2" | QL-537 QL-538 | All models |
|  | Thermostatic valve straight 1/2" Thermostatic valve straight 3/4" | QL-539 QL-540 | All models |
|  | Thermostatic valve angular 1/2" Thermostatic valve angular 3/4" | QL-541 QL-542 | All models |
|  | Lockshield valve straight 1/2" Lockshield valve straight 3/4" | QL-543 QL-544 | All models |
|  | Lockshield valve angled 1/2" Lockshield valve angled 3/4" | QL-545 QL-546 | All models |
|  | 3-way valve 1/2" 3-way valve 3/4" | QL-547 QL-548 | All models |
|  | 4-way valve 1/2" 4-way valve 3/4" | QL-549 QL-550 | All models |
|  | Balancing valve 1/2" Balancing valve 3/4" | QL-551 QL-552 | All models |
|  | Flexible couplings 1/2" Flexible couplings 3/4" | QL-553 QL-554 | All models |

ACCESSORIES

| Image | Description | Code | | Suitable for |
|---|--|--------|--------|-------------------|
|  | Thermostat head | QL-555 | | All models |
|  | Thermostat head - RAL 9016 | QL-556 | | All models |
|  | Thermostat head - RAL 9005 | QL-557 | | All models |
|  | Thermostat head - metal matte | QL-558 | | All models |
|  | Thermostat head - metal chrome | QL-559 | | All models |
|  | Thermostat head - white chrome | QL-560 | | All models |
|  | Cable temperature sensor | QL-561 | | All models |
|  | Thermostat head with remote regulator | 2m | QL-562 | All models |
| | | 5m | QL-563 | All models |
| | | 8m | QL-564 | All models |
|  | Thermostat head with remote regulator and temperature sensor | QL-565 | | All models |
|  | Thermal valve actuator 230V AC (NC) | QL-566 | | All models |
| | Thermal valve actuator 24V AC (NC) | QL-567 | | |
| | Thermal valve actuator 230V AC (NO) | QL-568 | | |
| | Thermal valve actuator 24V AC (NO) | QL-569 | | |
| | Valve actuator 24V DC; 0-10V | QL-570 | | All models |
|  | Condensate pump | QL-571 | | All models |
|  | Magnet switch - window/door | QL-572 | | All models |

FLOOR CONVECTORS - PKH

Standard delivery:

| | | | |
|---|--|---|--|
| Steel and aluminium parts powder coated in RAL 9005 | | Leveling mounts for height adjustment and casing fixing | |
| Efficient low volume heat exchanger with bleed valve 1/4" | | Protective plywood cover | |
| Silent 230V AC or 24V EC tangential fans | | Service cover | |
| Leveling screws | | PVC foil and carton box packaging with polystyrene corner and side protection | |
| Standard U frame | | Installation and operation manual | |
| Ground terminal | | Air valve on heat exchanger | |

Ordering key

Accessories

Type **PKF - 110 - 1 - 2000**

PKN / PKF / PKH / PKH-4C

PKF-EC / PKH-EC / PKH-4C-EC

QL-xxx

Casing height

70 (PKN); **110** (PKN, PKF); **130** (PKH, PKH-4C), **140** (PKN, PKF); **150** (PKH, PKH-4C)

1- row width 210/250 mm

2- row width 300/340 mm

3- row width 400/440 mm

Casing length [mm]

