

# FLOOR CONVECTORS

## PKH-4C

### Application

- Perfect for use in areas with high interior design requirements and spaces with large glass surfaces.
- Attractive solution used both as a primary or secondary heat source in water heating and/or cooling systems.

### Features

- Steel sheet casing powder coated in black color - RAL9005. Optional external 6 mm tick insulation.
- Cu/Al heat exchanger with profiled fins and 1/2" internal thread connections; each tested on 25 bar max pressure.
- Low noise tangential fans: 230V AC or 24V EC
- Wide range of attractive cover grilles made of anodized aluminium, wood or stainless steel in longitudinal or transverse roll-up design.
- Modular design allows easy connection and section adjustments
- Variety of accessories, regulation and inactive connection parts.

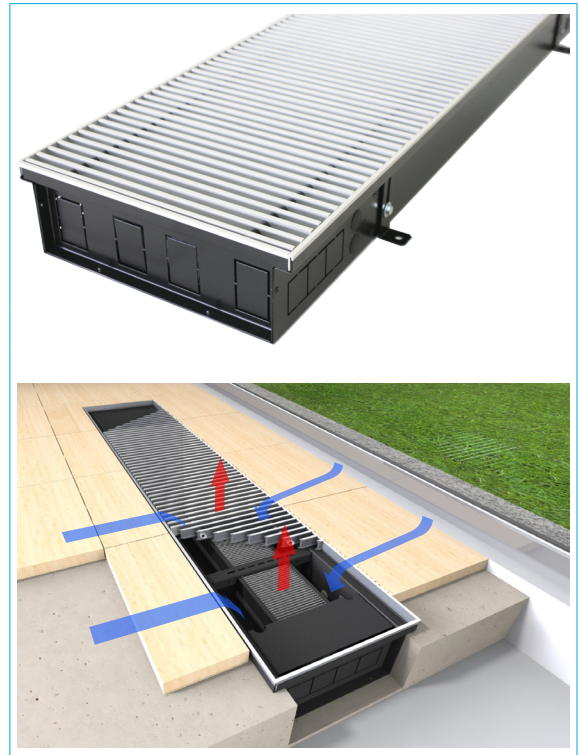

### Advantages

#### Intersecting cold air stream

In rooms with large glass surfaces, cold air downwash is present from glass surfaces towards the rest of the room. Floor convectors intersect the cold air stream, creating a warm barrier between cold glass surface and the rest of the room. It improves the room comfort and prevents fogging of the glass surfaces.

#### Cost effective

As an addition to floor heating system, floor convectors are great solution for short-term heating requirements during transitional periods between seasons. In this way heating is only delivered when necessary, avoiding unwanted heat transfer and saving money.

#### Instant heating

Heat exchangers provide rapid heat transfer due to large heat exchange surface. It is especially beneficial in combination with slow heating systems.

#### High heat output at low input water temperatures

In heating systems with low water temperatures, floor convectors with forced convection are used. The principle of forced convection greatly increases heat output.

#### Attractive design

Compared to classical heating systems, floor convectors are not using up usefull space nor interfering with room arrangement.

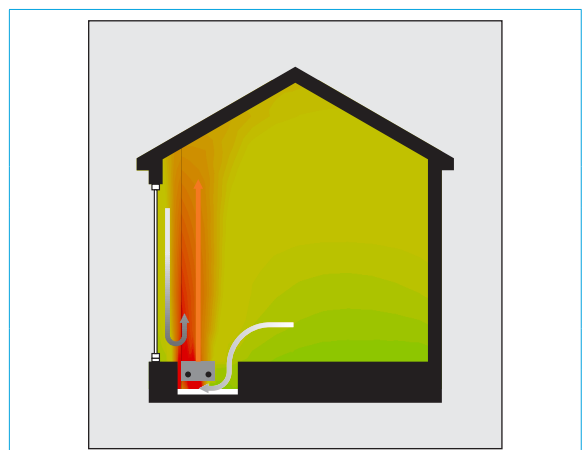
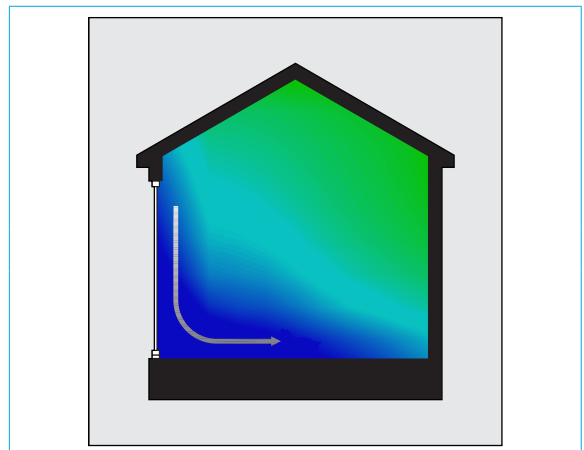

**PKH-4C** | HEATING and/or COOLING

- 4-pipe system for heating and/or cooling
- Condensate drain included

Length: 1200 to 3000 mm  
 Height: 130 or 150 mm  
 Heat output: 941 - 9181 W  
 Cooling output: 440 - 4439 W

Fans / Controls  
 230 V AC - 3 speed transformer  
 230 V AC - control 0-10 V  
 24 V EC - control 0-10 V  
 12 V DC - on request

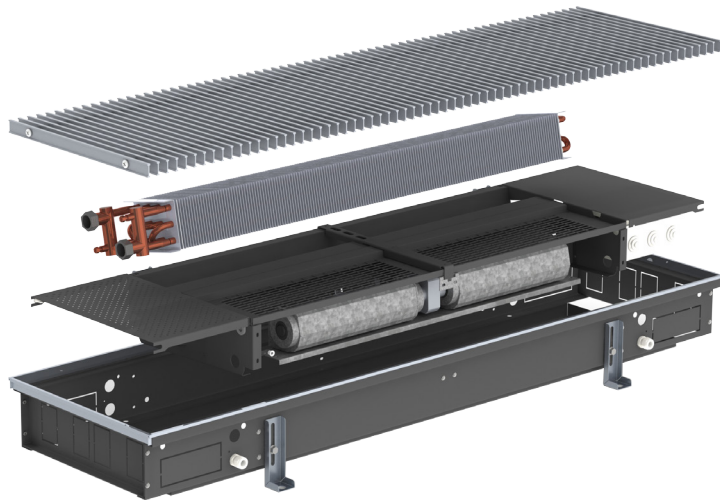

		PKH-4C-130						PKH-4C-150					
		LPHW			LPCW			LPHW			LPCW		
		90/70/20 °C	75/65/20 °C	55/45/20 °C	6/12/26 °C	10/15/26 °C	12/16/26 °C	90/70/20 °C	75/65/20 °C	55/45/20 °C	6/12/26 °C	10/15/26 °C	12/16/26 °C
<b>L = 1200 mm (1 fan)</b>													
Fan speed	MIN	-	-	-	-	-	-	1913	1586	941	755	523	440
	MED	-	-	-	-	-	-	2285	1880	1106	1110	767	627
	MAX	-	-	-	-	-	-	2727	2284	1350	1426	1013	855
<b>L = 2000 mm (2 fans)</b>													
Fan speed	MIN	-	-	-	-	-	-	3693	3069	1820	1494	1003	789
	MED	-	-	-	-	-	-	4310	3614	2113	2151	1454	1205
	MAX	-	-	-	-	-	-	5310	4410	2609	2853	1939	1640
<b>L = 2600 mm (3 fans)</b>													
Fan speed	MIN	-	-	-	-	-	-	5479	4526	2684	1903	1364	1237
	MED	-	-	-	-	-	-	6342	5216	3067	2723	1952	1751
	MAX	-	-	-	-	-	-	7864	6412	3880	4280	2688	2419
<b>L = 3000 mm (3 fans)</b>													
Fan speed	MIN	-	-	-	-	-	-	5955	5141	2792	2343	1703	1489
	MED	-	-	-	-	-	-	7018	5523	3149	2954	2093	1831
	MAX	-	-	-	-	-	-	9181	7425	4116	4439	2908	2566

Dimensions - PKH-4C

PKH-4C-130

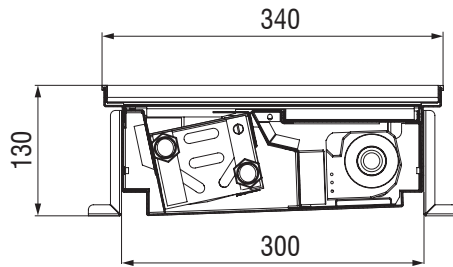

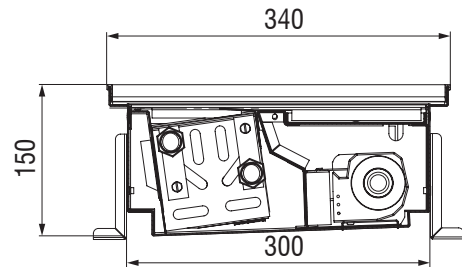

PKH-4C-150

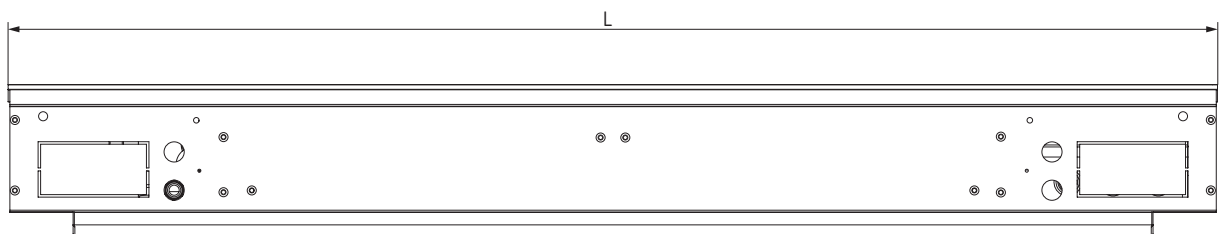
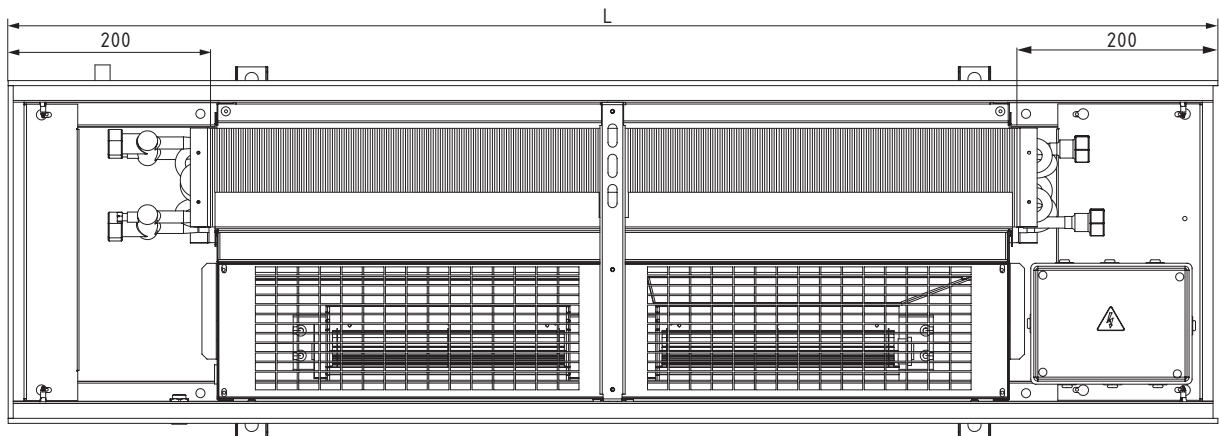

\*water connections R1/2"

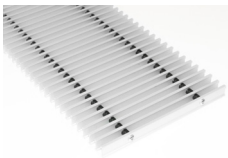
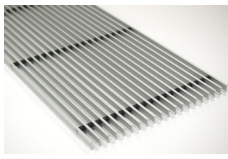

**ACCESSORIES**

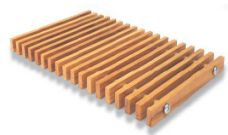
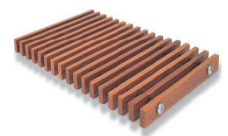
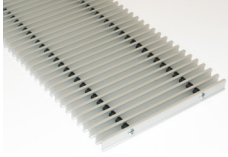
Image	Description	Code	Suitable for
	Roll-up aluminium grille (anodized in natural color)	QL-501-1	<b>All models - 1 row</b>
		QL-501-2	<b>All models - 2 row</b>
		QL-501-3	<b>All models - 3 row</b>
	Roll-up al. grille - anodized (light bronze, bronze, light brown, brown, black)	QL-502-1	<b>All models - 1 row</b>
		QL-502-2	<b>All models - 2 row</b>
		QL-502-3	<b>All models - 3 row</b>
	Roll-up al. grille - RAL...	QL-503-1	<b>All models - 1 row</b>
		QL-503-2	<b>All models - 2 row</b>
		QL-503-3	<b>All models - 3 row</b>
	Linear aluminium grille (anodized in natural color)	QL-504-1	<b>All models - 1 row</b>
		QL-504-2	<b>All models - 2 row</b>
		QL-504-3	<b>All models - 3 row</b>
	Linear al. grille - anodized (light bronze, bronze, light brown, brown, black)	QL-505-1	<b>All models - 1 row</b>
		QL-505-2	<b>All models - 2 row</b>
		QL-505-3	<b>All models - 3 row</b>
	Linear al. grille - RAL...	QL-506-1	<b>All models - 1 row</b>
		QL-506-2	<b>All models - 2 row</b>
		QL-506-3	<b>All models - 3 row</b>
	Roll-up grille - beech	QL-507-1	<b>All models - 1 row</b>
		QL-507-2	<b>All models - 2 row</b>
		QL-507-3	<b>All models - 3 row</b>
	Roll-up grille - oak	QL-508-1	<b>All models - 1 row</b>
		QL-508-2	<b>All models - 2 row</b>
		QL-508-3	<b>All models - 3 row</b>
	Roll-up grille - cherry	QL-509-1	<b>All models - 1 row</b>
		QL-509-2	<b>All models - 2 row</b>
		QL-509-3	<b>All models - 3 row</b>
	Roll-up grille - inox	QL-510-1	<b>All models - 1 row</b>
		QL-510-2	<b>All models - 2 row</b>
		QL-510-3	<b>All models - 3 row</b>



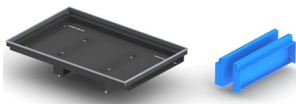
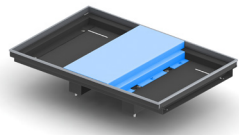
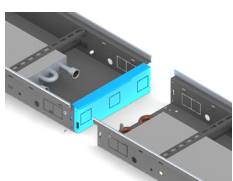







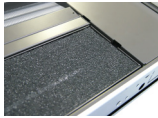



**ACCESSORIES**

Image	Description	Code	Suitable for	
	Optional F frame	QL-511	<b>All models</b>	
	Inactive section set (L=250 mm)	QL-512-701	<b>PKN 70</b>	1-row
		QL-512-702		2-row
		QL-512-703		3-row
		QL-512-111	<b>PKN 110 / PKF 110</b>	1- row
		QL-512-112		2-row
		QL-512-113		3-row
		QL-512-132	<b>PKH 130</b>	
		QL-512-141	<b>PKN 140 / PKF 140</b>	1-row
		QL-512-142		2-row
		QL-512-143		3-row
		QL-512-152	<b>PKH 150</b>	
		Inactive section set (L=500 mm)	QL-513-701	<b>PKN 70</b>
	QL-513-702		2-row	
	QL-513-703		3-row	
	QL-513-111		<b>PKN 110 / PKF 110</b>	1- row
	QL-513-112			2-row
	QL-513-113			3-row
	QL-513-132		<b>PKH 130</b>	
	QL-513-141		<b>PKN 140 / PKF 140</b>	1-row
	QL-513-142			2-row
	QL-513-143			3-row
	QL-513-152		<b>PKH 150</b>	
	Inactive section set (L=1000 mm)		QL-514-701	<b>PKN 70</b>
		QL-514-702	2-row	
		QL-514-703	3-row	
		QL-514-111	<b>PKN 110 / PKF 110</b>	1- row
		QL-514-112		2-row
QL-514-113		3-row		
QL-514-133		<b>PKH 130</b>		
QL-514-141		<b>PKN 140 / PKF 140</b>	1-row	
QL-514-142			2-row	
QL-514-143			3-row	
QL-514-153		<b>PKH 150</b>		
		Load bearing cover	QL-515-701	<b>All models</b>
	QL-515-702		2-row	
	QL-515-703		3-row	
	Casing connection piece	QL-516-701	<b>PKN 70</b>	1-row
		QL-516-702		2-row
		QL-516-703		3-row
		QL-516-111	<b>PKN 110 / PKF 110</b>	1- row
		QL-516-112		2-row
		QL-516-113		3-row
		QL-516-132	<b>PKH 130</b>	
		QL-516-141	<b>PKN 140 / PKF 140</b>	1-row
		QL-516-142		2-row
		QL-516-143		3-row
		QL-516-152	<b>PKH 150</b>	

**ACCESSORIES**

Image	Description	Code	Suitable for	
	Cut out section	QL-517-701	<b>PKN 70</b>	1-row
		QL-517-702		2-row
		QL-517-703		3-row
		QL-517-111	<b>PKN 110 / PKF 110</b>	1- row
		QL-517-112		2-row
		QL-517-113		3-row
		QL-517-132	<b>PKH 130</b>	
		QL-517-141	<b>PKN 140 / PKF 140</b>	1-row
		QL-517-142		2-row
		QL-517-143		3-row
		QL-517-152	<b>PKH 150</b>	
			Curved section	QL-518
	Corner section 90° Roll-up grille	QL-519-701	<b>PKN 70</b>	1-row
		QL-519-702		2-row
		QL-519-703		3-row
		QL-519-111	<b>PKN 110 / PKF 110</b>	1- row
		QL-519-112		2-row
		QL-519-113		3-row
		QL-519-132	<b>PKH 130</b>	
		QL-519-141	<b>PKN 140 / PKF 140</b>	1-row
		QL-519-142		2-row
		QL-519-143		3-row
		QL-519-152	<b>PKH 150</b>	
		Corner section 90° Linear grille	QL-520-701	<b>PKN 70</b>
	QL-520-702		2-row	
	QL-520-703		3-row	
	QL-520-111		<b>PKN 110 / PKF 110</b>	1- row
	QL-520-112			2-row
	QL-520-113			3-row
	QL-520-132		<b>PKH 130</b>	
	QL-520-141		<b>PKN 140 / PKF 140</b>	1-row
	QL-520-142	2-row		
QL-520-143	3-row			
QL-520-152	<b>PKH 150</b>			

**ACCESSORIES**

Image	Description	Code	Suitable for
	Filter G2	QL-521	<b>PKF, PKH, PKH-4C</b> (230V AC and 24V EC)
	External casing insulation	QL-522	<b>All models</b>
	Control box AT6	QL-523	<b>PKF, PKH, PKH-4C</b> (230V AC)
	Control box AT6-Relay	QL-524	<b>PKF, PKH, PKH-4C</b> (230V AC)
	Silent drive (230V AC; 0-10V)	QL-525	<b>PKF, PKH, PKH-4C</b> (230V AC)
	Room thermostat - wall (Siemens RAA 21)	QL-526	<b>PKN</b>
	Analog 3-step thermostat - wall (Siemens RAB 11)	QL-527	<b>PKF, PKH</b> (230V AC)
	Analog 3-step thermostat - wall (Siemens RAB 31)	QL-528	<b>PKH-4C</b> (230V AC)
	Digital thermostat - flush (Siemens RDF 510)	QL-529	<b>PKF, PKH</b> (230V AC)
	Digital thermostat - flush (Siemens 400.01)	QL-530	<b>PKF, PKH, PKH-4C</b> (230V AC)
	Frame for RDF thermostat	QL-531	
	Remote control for RDG and RDF	QL-532	
	Digital thermostat - wall (Siemens RDG 100T)	QL-533	<b>PKF, PKH, PKH-4C</b> (230V AC)
	Digital thermostat 0-10V - wall (Seitron TFZ01M)	QL-534	<b>PKF, PKH, PKH-4C</b> (230V AC)
	KOER Codis C35-FC (Temp.)	C35-FC	<b>PKF, PKH, PKH-4C</b> (230V AC and 24V EC)
	KOER Codis C35-FC-B/RS (Temp.-BACnet)	C35-FC-B/RS	
	KOER Codis C35-FC-H (Temp.-Humidity)	C35-FC-H	
	KOER Codis C35-FC-H-B/RS (Temp.-Humidity-BACnet)	C35-FC-H-B/RS	



**ACCESSORIES**

Image	Description	Code	Suitable for
	Service valve 1/2" Service valve 3/4"	QL-535 QL-536	<b>All models</b>
	Radiator valve straight 1/2" Radiator valve angled 1/2"	QL-537 QL-538	<b>All models</b>
	Thermostatic valve straight 1/2" Thermostatic valve straight 3/4"	QL-539 QL-540	<b>All models</b>
	Thermostatic valve angular 1/2" Thermostatic valve angular 3/4"	QL-541 QL-542	<b>All models</b>
	Lockshield valve straight 1/2" Lockshield valve straight 3/4"	QL-543 QL-544	<b>All models</b>
	Lockshield valve angled 1/2" Lockshield valve angled 3/4"	QL-545 QL-546	<b>All models</b>
	3-way valve 1/2" 3-way valve 3/4"	QL-547 QL-548	<b>All models</b>
	4-way valve 1/2" 4-way valve 3/4"	QL-549 QL-550	<b>All models</b>
	Balancing valve 1/2" Balancing valve 3/4"	QL-551 QL-552	<b>All models</b>
	Flexible couplings 1/2" Flexible couplings 3/4"	QL-553 QL-554	<b>All models</b>

**ACCESSORIES**

Image	Description	Code		Suitable for
	Thermostat head	QL-555		<b>All models</b>
	Thermostat head - RAL 9016	QL-556		<b>All models</b>
	Thermostat head - RAL 9005	QL-557		<b>All models</b>
	Thermostat head - metal matte	QL-558		<b>All models</b>
	Thermostat head - metal chrome	QL-559		<b>All models</b>
	Thermostat head - white chrome	QL-560		<b>All models</b>
	Cable temperature sensor	QL-561		<b>All models</b>
	Thermostat head with remote regulator	2m	QL-562	<b>All models</b>
		5m	QL-563	<b>All models</b>
		8m	QL-564	<b>All models</b>
	Thermostat head with remote regulator and temperature sensor	QL-565		<b>All models</b>
	Thermal valve actuator 230V AC (NC)	QL-566		<b>All models</b>
	Thermal valve actuator 24V AC (NC)	QL-567		
	Thermal valve actuator 230V AC (NO)	QL-568		
	Thermal valve actuator 24V AC (NO)	QL-569		
	Valve actuator 24V DC; 0-10V	QL-570		<b>All models</b>
	Condensate pump	QL-571		<b>All models</b>
	Magnet switch - window/door	QL-572		<b>All models</b>

## FLOOR CONVECTORS - PKH-4C

### Standard delivery:

Steel and aluminium parts powder coated in RAL 9005		Leveling mounts for height adjustment and casing fixing	
Efficient low volume heat exchanger with bleed valve 1/4"		Protective plywood cover	
Silent 230V AC or 24V EC tangential fans		Service cover	
Leveling screws		PVC foil and carton box packaging with polystyrene corner and side protection	
Standard U frame		Installation and operation manual	
Ground terminal		Air valve on heat exchanger	

### Ordering key

### Accessories

Type **PKF - 110 - 1 - 2000**

**PKN / PKF / PKH / PKH-4C**  
**PKF-EC / PKH-EC / PKH-4C-EC**

**QL-xxx**

Casing height  
**70** (PKN); **110** (PKN, PKF); **130** (PKH, PKH-4C), **140** (PKN, PKF);  
**150** (PKH, PKH-4C)

1- row width 210/250 mm  
 2- row width 300/340 mm  
 3- row width 400/440 mm

Casing length [mm]

